

# Factors analysis of water hammer in FLOWMASTER for main feedwater systems of PWR nuclear power plants

WANG Xin<sup>1</sup>, HAN Wei-shi<sup>2</sup>

1. College of Nuclear Science and Technology, Harbin Engineering University, 145 Nantong Street, Harbin 15001, People's Republic of China (wxhaijun@yahoo.com.cn)

2. College of Nuclear Science and Technology, Harbin Engineering University, 145 Nantong Street, Harbin 150001, People's Republic of China (hanws2007@163.com)

**Abstract:** The main feedwater system of a nuclear power plant (NPP) is an important part in ensuring the cooling of a steam generator. It is the main pipe section where water hammers frequently occur. Studying the regular patterns of water hammers in the main feedwater systems is significant to the stable operation of the system. This article focuses on a parametric study to avoid the consequences of water hammer effect in PWR by employing a general purpose fluid dynamic simulation software-FLOWMASTER. Through FLOWMASTER's transient calculating functions, a mathematical model is established with boundary conditions such as feedwater pumps, control valves, *etc.*, calculations of water hammer pressure when feedwater pumps and control valves shut down, and simulations during instantaneous changes in water hammer pressure. Combining a plethora of engineering practical examples, this research verified the viability of calculating water hammer pressure through FLOWMASTER's transient functions and we found out that, increasing the periods of closure of control valves and feedwater pumps control water hammers effectively. We also found out that changing the intervals of closing signals to feedwater pumps and control valves aid to relieve hydraulic impact. This could be a guideline for practical engineering design and system optimization.

**Keywords:** water hammers; main feedwater system; nuclear power plant; simulation

## 1 Introduction

When a fluid in the pressure pipe changes its flow velocity suddenly due to some reasons, the fluid's inertia will cause a rapid change of the flow pressure in the pipe. This is what is termed as 'water hammer' or 'fluid hammer' phenomenon. Generally, water hammer pressure can be a few times greater than normal pressure or even higher. Thus, it poses a great threat to the steady operation of the feedwater systems of nuclear power plants. From early 1969 to mid-1981, nuclear power stations in the US reported nearly 150 water hammer accidents, including 67 in pressurized water reactors, with 13 of them happening in feedwater systems<sup>[1]</sup>. Therefore, this clearly shows the significance of water hammer research with regard to the safe functioning of nuclear power stations.

The history of water hammer research goes back as early as the mid-nineteenth century, when Wilhelm Weber measured the transmission velocities of water

hammer waves in pressure pipes and the influence of pipe elasticity on the transmission velocity of the water waves. The following few decades saw significant developments in the academic research on water hammers. In 1913, Loreuzo Allievi developed the fundamental equation of unsteady flow using mathematical methods; he also laid down the theoretical foundation of water hammer research and created mathematical as well as graphical methods to analyze water hammers. In the 1960s, with rapidly developing computer technology, it was possible to calculate and simulate more complicated water hammers, and water hammer analysis progressed to a new stage. Analytical, graphical and numerical methods are all used to compute water hammers<sup>[2]</sup>. Amongst them, the numerical method is the most developed and extensively used method adopted by many water hammer calculation programs, such as EASYPIPE, KEDPU, FLOTRAN<sup>[3, 4]</sup>, *etc.*

Although there is still a gap existing in the area of water hammer research in China as compared to other countries, achievements in the theory of water hammers and water hammer prevention have also

---

**Received date: August 4, 2010**

(Revised date: September 15, 2010)

been obtained<sup>[5-7]</sup>. FLOWMASTER is currently the world's most famous thermal fluid system simulation program, much used by world-renowned institutes because of its high computational efficiency, accurate solving ability as well as its fast and convenient way of modeling. Some Chinese institutes and nuclear power plants have started to use this software in the simulation of nuclear power plant systems, but are still at the primary trial stages-water hammer simulations and computing applications is relatively dormant. In the research tied to this paper, FLOWMASTER was used to model a nuclear power plant feedwater system, simulating the process of water hammer occurrence and attenuation through transient functional calculations. This research focuses on the theory of water hammer formation and explores the roles of the relevant factors affecting its formation.

## 2 Fundamental theories of water hammers

The main causes of water hammer phenomenon include the rapid change in valve position, opening and shutdown of a pump or a turbine, the flow control of control valves, heat changes in the system and/or vibration of components in the system (such as reciprocating machinery). The detailed process of water hammer phenomenon has been widely described; with the exception of the main formula, this paper will not reproduce such information.

The maximum pressure of water hammers happens before the control valves. The value can be deduced from the Joukowsky equation<sup>[8]</sup>:

$$\Delta p = \rho \cdot c \cdot \Delta v \quad (1)$$

where:  $\Delta p$ : pressure wave magnitude (N/m<sup>2</sup>)  
 $\rho$ : fluid density (kg/m<sup>3</sup>)  
 $c$ : wave velocity (m/s)  
 $\Delta v$ : change in the fluid's velocity (m/s)

When the valve is shut down, the fluid flows are obstructed, resulting in strong pressure fluctuations – the maximum pressure of which is at the valve. Pressure waves propagate in the pipe back and forth, gradually reducing as a result of friction in the pipeline.

The propagation velocity of a pressure wave can be estimated by the following Eq. (2):

$$c = \frac{c_0}{\sqrt{1 + \frac{Kd}{Es}}} \quad (2)$$

in which:

$c$ : velocity (m/s)

$K$ : bulk modulus of fluids (N/m<sup>2</sup>)

$d$ : pipe diameter (m)

$s$ : pipe thickness (m)

$E$ : Young's modulus of the pipe material (N/m<sup>2</sup>)

The deformation of the pipe wall can be treated by Eq. (2).

The velocity of the pressure wave in an unbounded fluid  $c_0$  is calculated as follows:

$$c_0 = \sqrt{\frac{K}{\rho}} \quad (3)$$

In particular, the propagation velocity of the pressure wave in unbounded water is ca.1420m/s. When considering the deformations in the pipe wall, the wave velocity slows down by a factor of

$$\frac{1}{\sqrt{1 + \frac{Kd}{Es}}}$$

## 3 Numerical value simulations

### 3.1 Construction of model

Before the construction of a system model, some simulation conditions must be confirmed. There are several modules in the software in which systems would be constructed and simulated from. For instance, there is Single Phase Module and Fluid Power Module in the software. The Single Phase Module also includes Incompressible and Compressible Modules as shown in Fig.1<sup>[9]</sup>. Incompressible Module is mainly used for liquids and low pressure gaseous fluid systems calculations. Compressible Module is mainly used for gas systems analysis, including steady-state and dynamic analysis, and Fluid Power Module is for hydraulic systems. We hereby choose the General Liquid Systems -Transient Model because it is suited for liquids and provides transient data of systems.

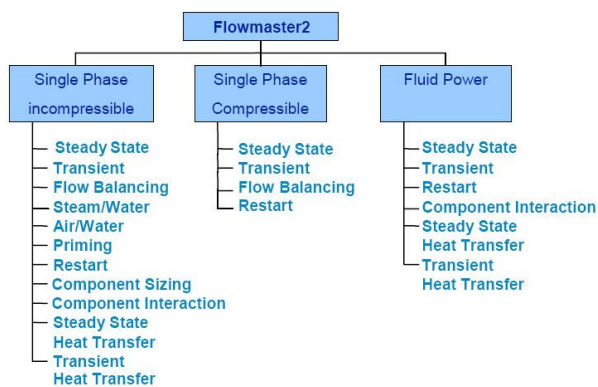

Fig.1 Modules of FLOWMASTER software.

This research focuses on the formation and decay of water hammers and establishes a model of a feedwater system in a nuclear power plant's secondary loop. The scope of the study started with the exit of a de-aerator to the entrance of a steam generator. The reference here is Daya Bay Nuclear Power Plant<sup>[10]</sup>. A Model diagram of the system is shown in Fig. 2. The inlet pressure source is the exit of the de-aerator, and the outlet pressure source is the exit of the steam generator. Three groups of feedwater pumps are in parallel in the feedwater system. Each group also includes a booster pump and a force pump. Two heat exchangers are designed for heating the feedwater, considering that they are not the direct factors involved in the formation of water hammers. They are simplified as pressure drop components in the model system (pressure drop parameter is shown in Table 1).

There is a control valve fitted in each of the three parallel pipes and the valves have the same structural conditions. In addition, three observation nodes before the control valves are in the same situation; the pressure curves are the same in different observation nodes. Any of the three observation nodes will be analyzed after simulation.

### 3.2 Basic parameters

After designing the model, all relevant parameters should be entered into all components of the model. Meanwhile, the characteristic curves (opening vs. flow curve) of feedwater pumps and control valves should be imported. Openings of pumps and valves refer to the circulation condition of the fluid. When opening is 1, pumps and valves are completely open; when opening is 0, pipes are completely shut down.

The basic parameters of the components to fill in are shown in Table 1 below.

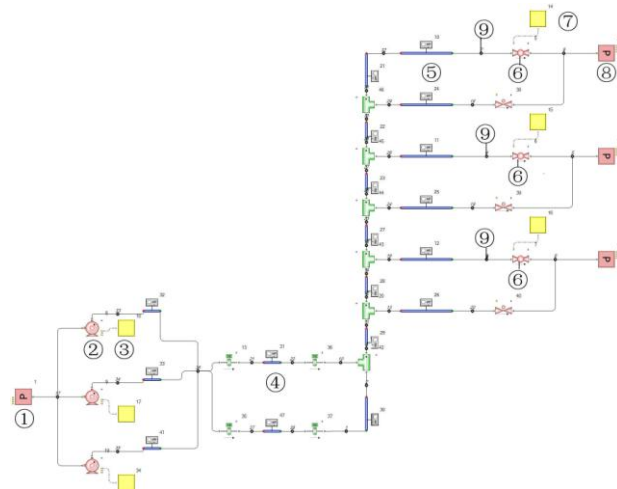

Explanation:

- ① Inlet pressure source
- ② Feedwater pump
- ③ Pump controller
- ④ Heat exchanger
- ⑤ Pipe
- ⑥ Control valve
- ⑦ Valve controller
- ⑧ Outlet pressure source
- ⑨ Observation node before control valve

Fig.2 Model diagram of system.

Table 1 Model parameters

Names of components	Parameters	Value
Inlet pressure source	Pressure	0.9 MPa
Outlet pressure source	Pressure	6.88 MPa
Feedwater pump (booster pump /force pump)	Flux	813.50 kg/s
	Rated head	268/586.8 m
	Rotating speed	1493/4775 rpm
	Rated power	2517/5445 kW
	Moment of inertia of pump	2.5 kgm <sup>2</sup>
	Moment of inertia of motor	519 kgm <sup>2</sup>
Pump controller	Closure time	10 s
Pipe	Length	24.9 m
	Absolute roughness	0.025 mm
	Diameter	0.4064 m
Control valve	Diameter	0.4064 m
	Opening of valve	1
Valve controller	Closure time	1~5s
Heat exchanger	Pressure	0.067 MPa

### 3.3 Simulation

Prior to running the model, other simulation parameters have to be entered. Select the "Transient

simulation" as the type of simulation, and then calculate the time step and input it. In addition, enter the starting as well as the ending time of the simulation.

Transient calculation of pipeline parameters needs the Transient Pipeline Model, including Rigid and Flexible Channel Pipeline Models. Since the pipeline is considered to be flexible in water hammers study, the Flexible Channel Pipeline Model is hitherto adopted. This model is used to simulate the fluid flow and the effect of the water hammers on the elastic pipeline. The method of characteristics is also employed here, therefore users need to define all the flexible pipe network model grid scale. Using the grid scale formula of an elastic pipeline shown below, grid number  $S$  must be within  $\pm 0.2$  of an integer greater than 3. To meet the constraints of the  $S$  value for all the channels, the user needs to constantly adjust the  $L$ ,  $c$  and  $\Delta t$  value. After several trials, the time step is worked out to be 0.05s.

$$S = \frac{L}{c\Delta t} \quad (4)$$

where:

- L: length of the pipe before control valve (m)
- C: wave velocity (m/s)
- S: grid number
- $\Delta t$  : time step (s)

Duration can be set according to the requirements of the simulation. The longer the start-stop time interval is, the more time calculation will take. The pressure significantly fluctuates at the initial period of water hammers effect after which it starts to rapidly increase. Many simulation experiments show the water hammer pressure gradually decreasing after 10s (when the feedwater pump is completely closed) and may take about 300s for it to show a stable value. In order to observe the water hammer effect, we hereby choose a starting and ending time of 0s and 20s respectively. When all the parameters are checked (and are correct), click on the "Run" icon to simulate and thereafter, click on the "Results" icon to view the results.

## 4 Result of simulation by FLOWMASTER

After simulation, the parameters on the nodes and the transient characteristics of the components can be obtained (such as transient pressure, etc.).

### 4.1 Result of reference case

The maximum pressure ( $\Delta p$ ) of a water hammer happens before the valve, and continues to weaken in the process of transmission. The pressure curve on the node before the valve is shown in Fig.3, which is also the reference case study of the water hammer simulation. Further studies on the parameter changes are discussed from 4.2 to 4.5.

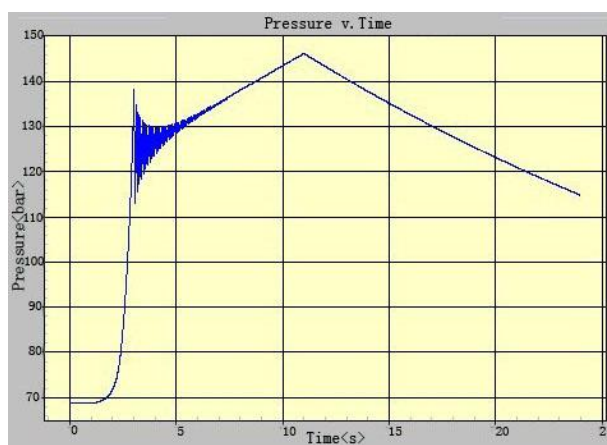

Fig.3 The pressure curve before control valves (the reference case study of the water hammer simulation).

#### 4.1.1 First pressure peak

Figure 3 above indeed shows the water hammer phenomenon occurring in the pipeline. During the process of closing the valve, the opening of the valve decreases and the flow rate increases, consequently causing a rapid rise in the pressure before the valve. When the valve is completely closed, significant pressure fluctuations (*i. e.*, water hammers) happen; the pressure creates its first peak in an instant and the water hammer decays constantly in the spreading process due to dampening of the oscillations and the stabilization of the pressure fluctuations.

#### 4.1.2 Second pressure peak

Due to moment of inertia acting in the feedwater pump, even after receiving the close signal, the pump continues to work for some time (the closure of the

valve requires a relatively shorter time). During this period, the fluid in the pipe between the feedwater pump and the control valve accumulates, leading to a steady rise in the fluid pressure in the pipe. When the pump is completely closed, the pressure increases up to its maxima, which is the second pressure peak. In this period of the pressure curve, the fluid accumulation pressure has been the dominant factor in the pressure wave instead of the water hammer pressure. During the posterior segment of the pressure curve, there are still small fluctuations due to dampening of the water hammer shock, but it is not the main factor behind it.

The simulation above was carried out under the condition of the actual parameters shown in Table 1. The result shows that the maximum pressure of water hammers is *ca.* 140 bar (1bar is equivalent to 0.1MPa) which is exact to the limiting value of control valve-it means the simulation verifies it is appropriate to make 140 bar as the limiting value of the control valve. Compared with an actual situation, the simulation results show a high correlation to actual operating conditions. To analyze the factors affecting water hammers, change only one factor in the same model diagram of the system each time and compare them.

#### 4.2 Result of valve closure time changes

The valve closure time is increased from 3s to 5s in order to analyze its influence. The pressure curves are shown separately on Fig.3 and Fig.4. The pressure curves illustrate that the extension of the valve closing time may reduce the pressure peak and frequency of fluctuations. The effect of water hammers declines when the valve closing time is shortened, and the pressure may be more dramatic, reaching a higher peak as well as showing a higher frequency. This shows that the water hammers effect is happening.

#### 4.3 Result of pump closure time changes

The complete closure time of the pump is also significant to water hammers, especially to the second pressure peak after the emergency closure signal. Figures 3 and 5 show the pressure fluctuations during pump closure time of 10s and 5s respectively.

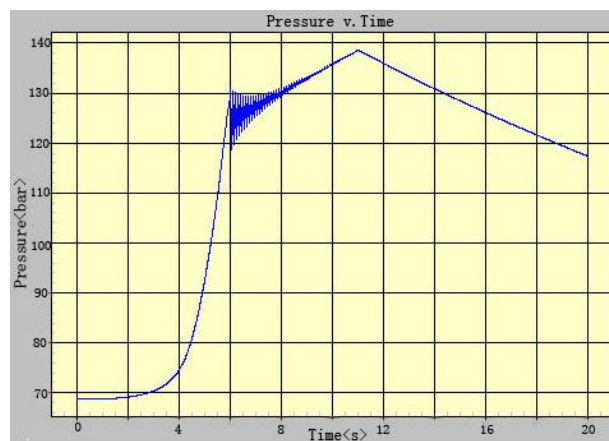

Fig.4 The pressure curve before control valves (the situation of valve closing time is 5s).

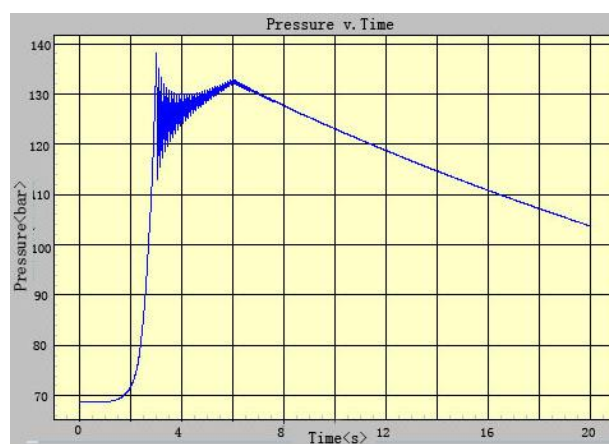

Fig.5 The pressure curve before control valves (the situation of pump closing time is 5s).

From the observations above, it is clear that the more time the pump takes to completely shut down, the more apparent the pressure fluctuation in the pipes is. This contribution is reflected in the pressure accumulation, and ultimately reflected in the second pressure peak.

#### 4.4 Result of interval change between pump and valve closure time

With regard to the above analysis, research on the effect to water hammers vis-a-vis complete closure times of pumps and valves is carried out under the same conditions, *i.e.* both the pump and the valve are triggered by the same signal - the pump and the valve start to shut down after receiving the same signal. Furthermore, the condition of closure by different signals can be considered because there is a certain

time interval between the two signals of closing a pump and a valve.

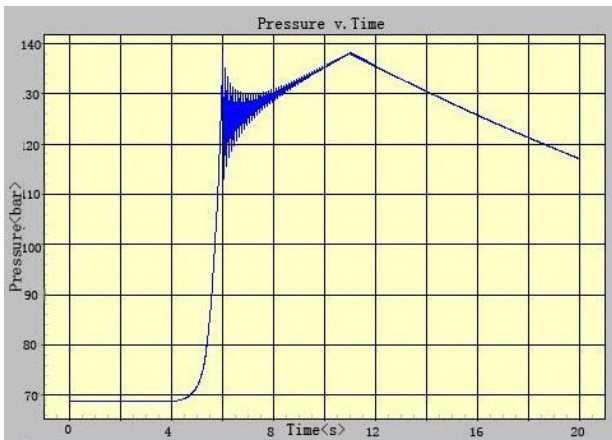

Fig.6 The pressure curve before control valves (the situation of valve closing 3s later).

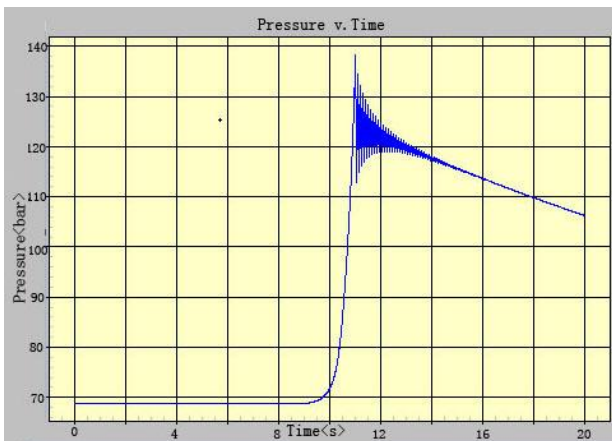

Fig.7 The pressure curve before control valves (the situation of valve closing 8s later).

When a comparative approach was taken, there was no change in any parameter, except the interval between the two signals. The intervals were changed to 0s, 3s and 8s and the results of the same signal and two different ones were compared.

With respect to the analysis shown on Figs. 3, 6 and 7, if there is a delay in the valve closing signals, the first pressure peak moves closer to the second one; the growth process of the second pressure peak gets shorter, resulting in the value of the second peak decreasing. When the interval between the two signals is 8s, the pump and the valve shut down completely at the same time and the two pressure peaks merge to become one peak (as shown in Fig. 7). At this time, the role of the fluid accumulation has

become smaller while the water hammers become the dominant factor of the pressure fluctuations.

#### 4.5 Result of the changes in pipe diameter

During the course of the simulation, the effect of the pipe diameter to the water hammers was explored. Pipe diameters of 0.2m and 0.4m were analyzed with regard to water hammer effects.

Compared with Figs. 3 and 8, the research shows that the changes in the pipe diameter are not directly related to the maximum pressure of water hammers. In addition, the value of pressure fluctuations peak is not affected by the diameter of the pipeline, which also confirms the maximum pressure formula introduced previously. Moreover, the effect of diameter is reflected on the amplitude decay rate of damping vibration from water hammers.

The water hammers pressure fluctuations happen when the valve is shut down and there is maximum pressure value on the instant of valve complete closure; decaying gradually when spreading back and forth. The diameter has an effect on the rate of attenuation. The loop with the diameter of 0.4m can quickly stabilize pressure fluctuations after water hammers occurrence, with a higher rate of amplitude vibration. On the other hand, the loop with the diameter of 0.2m requires more time to weaken the pressure fluctuations with higher sustained amplitude. Although the two maximum pressure values are accordant with each other, the pipe with the smaller diameter has a higher amplitude vibration and thus has a bigger impact on the pipeline.

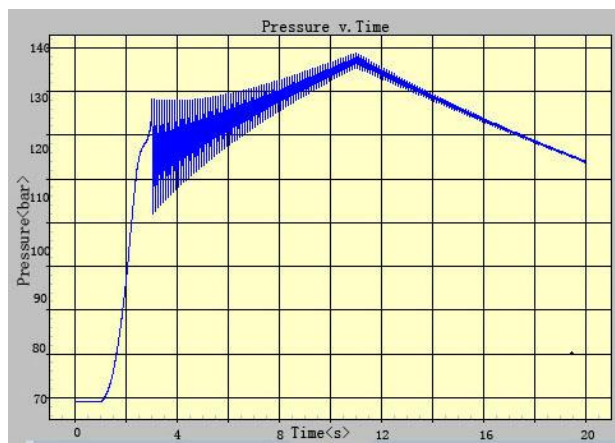

Fig.8 The pressure curve before control valves (0.2m diameter).

## 5 Conclusions

Water hammers are important issues relating to the stable and reliable operation of NPP feedwater systems. This research highlights on the effective use of FLOWMASTER software for the safety design of feedwater system to control the water hammer effect. The reliability of these simulation models and the results has been verified by comparisons with actual conditions. The results show that in the simple pump - valve system, the complete closure times of valves and pumps have considerable influence on the formation of water hammers. Idle time of the feedwater pump increases the fluid accumulation pressure, intensifying pressure vibration. On the contrary, the pump idler has a positive impact on the inherent safety of the main feedwater system. Even though pipeline diameter has an effect on the amplitude of the pressure wave of water hammers, flow rate is still the main factor in the process of pipeline diameter design. Whether or not to use synchronized signals to shut down the control valves and feedwater pumps requires further discussion (*e. g.*, the synchronized closure signals contribute to a rapid system shutdown in an emergency, while the de-synchronized closure signals help to mitigate water hammers). As a result, it is necessary to consider all the above factors in the design of feedwater systems. Further study for the practical application is to establish a more consummate model of feedwater systems. The impact of systems after control valves to water hammers will also be considered.

## Acknowledgement

In the process of this research, quite a number of people assisted the authors, particularly Ms. Zhao Jiaming, in the field of simulation data use as well as

Professor Gower, on the subject of professional English. Last but not least, the authors feel indebted from the unwavering support they received from their parents.

## References

- [1] LIU, S.: American Nuclear Power Plants Water Hammers Review, Nuclear Power Engineering, 1987, 8(3):1-14. (in Chinese).
- [2] ZHAO, J.: The Study of Water Hammer Installation, Simulation and Calculations in First Loops of Nuclear Power Plants, Harbin Engineering University, Harbin, 2008. (in Chinese).
- [3] USPURAS, E., KALIATKA, A., DUNDULIAS, G.: Analysis of Potential Water Hammer at the Ignalina NPP Using Thermal-hydraulic and Structural Analysis Codes, Nuclear Engineering and Design, 2001(203):1-12.
- [4] BERGANT, A., SIMPSON, A.R., TIJSSELING, A.S.: Water Hammer with Column Separation, Journal of Fluids and Structures, 2006(22):135-171.
- [5] LIU, Z., LIU, G., SU, F.: Numerical Simulation of Pump-Stopping Water Hammer in Tertiary Circulating Water System of PWR Nuclear Power Plant, Nuclear Power Engineering, 2005, 26(5):502-505. (in Chinese).
- [6] YANG, Y., DENG, Z.: Pump-Stopping Water Hammer Calculation and Safety Measures, Chinese Water Supply & Drainage, 2000,16(5): 29-32. (in Chinese).
- [7] HU, Z., WANG, W., MENG, H.: A Dynamic Analysis of Second Loop Water Hammers in the Water Supply of a Nuclear Power Plant, Ship & Ocean Engineering, 2007,36(3):90-93. (in Chinese).
- [8] THORLEY, A.D.R.: Fluid Transients in Pipeline Systems -2nd ed. Professional Engineering Publishing, 2004.
- [9] FLOWMASTER2 Chinese Technical Manual, Beijing: Beijing Sea-based Technology Development Co., Ltd., 2006. (in Chinese).
- [10] GUANGDONG NUCLEAR POWER TRAINING CENTER: Devices & Systems of 900MW PWR, Beijing: Atomic Energy Press, 2005. (in Chinese).