

# Break probability calculation and sensitivity analysis of horizontal pressure pipe

CUI Qinglan<sup>1</sup>, GUO Yun<sup>1</sup>, and PENG Changhong<sup>1</sup>

1. School of Nuclear Science and Technology, University of Science and Technology of China, Room 1312, Science and Technology Laboratory Building (East), West Campus of USTC, Shushan District, 230027, China  
(cqlc@mail.ustc.edu.cn; guoyun79@ustc.edu.cn; pengch@ustc.edu.cn)

**Abstract:** This study referred to the algorithm of PRAISE (Piping Reliability Analysis Including Seismic Events) computer code, selected several horizontal pressure pipes of different sizes, and calculated the break probabilities at a weld joint of these pipes under different operating conditions. The influence of pipe sizes and operation conditions on break probability was analyzed. The conclusion is that the rise of temperature and pressure will increase the break probability, and the increase in the wall thickness will decrease the break probability. By using ultrasonic examination, the probability of pipe break can be reduced.

**Keyword:** pipe break; crack; PRAISE computer code

## 1 Introduction

Loss-of-coolant accident (LOCA) is a mode of failure of a nuclear reactor. If not managed effectively, the results of a LOCA could result in reactor core damage. Pipe break is an important cause of LOCA, so it is necessary to reduce the probability of pipe break.

The PRAISE (Piping Reliability Analysis Including Seismic Events) computer program was developed for the Load Combination Program at the Lawrence Livermore National Laboratory by Science Applications, Inc. It can estimate the probability of failure at a weld joint in the primary coolant system of a pressurized water reactor [1]. PRAISE program is widely used in the estimation of pipe leakage and LOCA probabilities of nuclear power plants. The calculation method used in this study is based on the algorithm of PRAISE computer code.

The objects of this study are a series of horizontal pressure pipes. To analyze the influence of temperature, pressure, outside diameter and pipe thickness, we calculated the break probabilities at a weld joint of these pipes under different operating conditions. The conclusion of this study has a reference value for other pipe break studies.

## 2 Calculation method

The purpose of PRAISE program is to estimate the failure probability of a specific weld in the primary coolant system by using Monte Carlo simulation.

The PRAISE model assumes that failure of a weld joint stems from fatigue growth of an as-fabricated defect. The main steps of the algorithm are as follows: first, it assumed a semi-elliptical as-fabricated surface crack at the inner pipe wall. The crack geometry is shown in Fig. 1. The size of the crack is defined by crack depth and aspect ratio, which are independent variables and have their own probability density functions. Then, the semi-elliptical as-fabricated defects continue to grow as semi-elliptical defects under operating conditions of the nuclear power plant. If pre-service and in-service inspections of piping weldments are performed, the algorithm will calculate the probability of not detecting the crack. During the plant lifetime, if the crack depth reaches the pipe wall thickness, and it is not detected by inspections, a LOCA occurs. By doing Monte Carlo simulation of as-fabricated surface cracks, we can get the probability of pipe break. The basic PRAISE flowchart is shown in Fig. 2.

A key ingredient in the PRAISE algorithm is the sample space representation of the Monte Carlo simulation. From a physical standpoint, the sample space is a two-dimensional representation with two coordinates. In order to facilitate the calculation, the

---

**Received date: July 10, 2017**  
(Revised date: January 14, 2018)

PRAISE algorithm uses the reciprocal of the aspect ratio which is  $a/b$  in Fig. 1 as one coordinate, and the new crack depth which is normalized by dividing by the wall thickness as the other coordinate. Stratified sampling is used to improve efficiency. The stratification of the sample space is shown in Fig. 3.

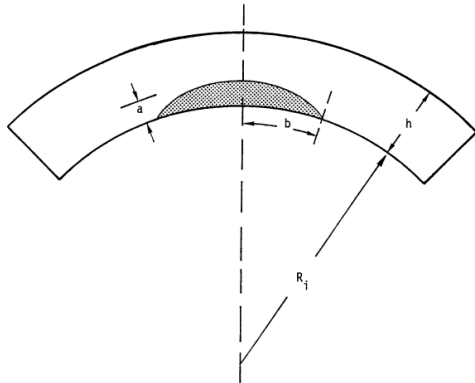

Fig.1 Crack geometry.

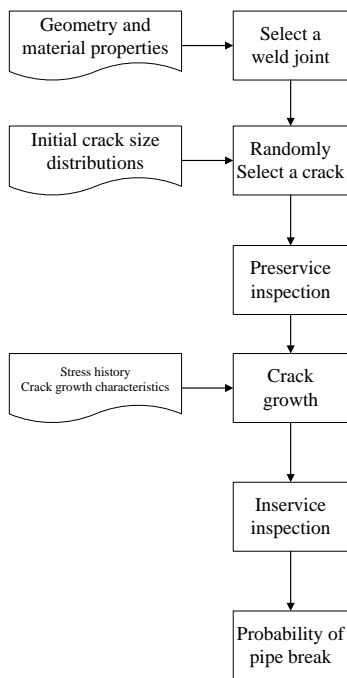

Fig.2 Basic PRAISE flowchart.

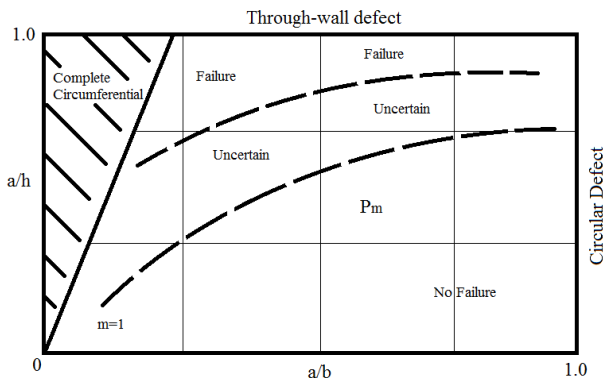

Fig.3 Stratification of the sample space.

In the calculation of crack growth, PRAISE assumes that the growth rate for each dimension is controlled by an RMS-averaged stress intensity factor associated with that growth direction. The algorithm firstly calculates the minimum and maximum values of the RMS stress intensity factor during the cyclic loading, which are  $\bar{K}_{max}$  and  $\bar{K}_{min}$  in Eq. 1. Then the effective cyclic stress intensity factors which are defined by Eq. 1 are obtained. If the effective cyclic stress intensity factor is bigger than the threshold value of the stress intensity factor, the crack grows, and the amount is  $C(\Delta\bar{K})_{eff}^4$ , where C is the fatigue crack growth parameter.

$$(\Delta\bar{K})_{eff} = \frac{\bar{K}_{max} - \bar{K}_{min}}{\sqrt{1 - \frac{\bar{K}_{min}}{\bar{K}_{max}}}} \quad (1)$$

Pre-service and in-service inspections of piping weldments are performed using ultrasonic testing. The probability of not detecting a crack of depth 'a' can be approximated by Eq. 2, Eq. 3 and Eq. 4.

$$P_{ND}(A) = \frac{1}{2} \operatorname{erfc}\left(v \cdot \ln \frac{A}{A^*}\right) \quad (2)$$

$$A^* = \frac{\pi}{4} D_B \cdot a^* \quad (3)$$

$$A = \begin{cases} \frac{\pi}{2} ab & \text{if } 2b < D_B \\ \frac{\pi}{2} a \frac{D_B}{2} & \text{if } 2b \geq D_B \end{cases} \quad (4)$$

$D_B$  is the diameter of the ultrasonic beam. The PRAISE model assumes that  $D_B$  is 1 inch,  $v$  is taken as 1.60, and  $a^*$  is the crack depth which has a 50-50 chance of being detected.

After the calculation, the probability of pipe failure at or before time  $t$  is given by Eq. 5.

$$p(t_F \leq t) = \sum_{m=1}^M \frac{N_{F,m}(t)}{N_m} p_m \quad (5)$$

The main calculation method of PRAISE algorithm is above. Figure 4 is the Schematic of PRAISE program.

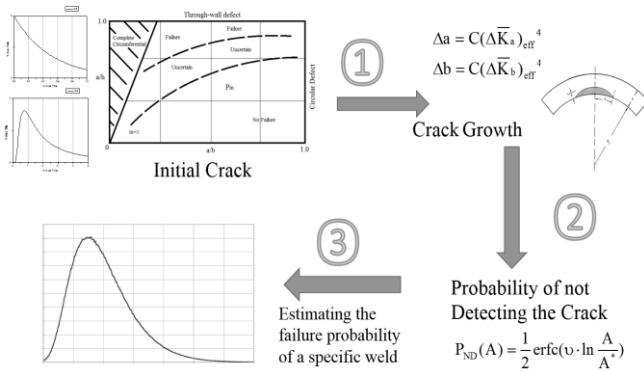

Fig.4 Schematic of PRAISE program.

### 3 Calculation object

The calculation objects of this study is a series of horizontal pressure pipes. Two ends of the pipes are supported by stents. The material of the pipes is ferritic steels. And the fluid in the pipes is water. We assume that there is a weld at the middle of the pipe, and calculate the probability of pipe break at this weld. The schematic is shown in Fig. 5.

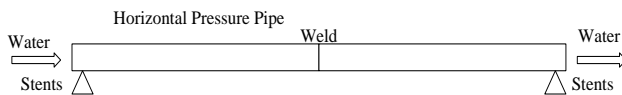

Fig.5 Schematic of calculation object.

All the sizes of the pipes calculated in this study, including pipe length, outside diameter and pipe wall thickness, are selected from *Dimensions, Shapes, Masses and Tolerances of Seamless Steel Tubes* [2].

The operation conditions of the pipe are referred to the primary coolant system of a pressurized water reactor. Every cyclic loading has the same pressure and temperature, which are referred to *Design Code for Industrial Metallic Piping* [3], to ensure the maximum stress in the pipe is less than the allowable stress of ferritic steels [4].

To analyze the probability of pipe break in a relatively long period, the calculations of all the conditions are calculated in 100 cyclic loadings, and we recorded the probability in every 10 cyclic loadings.

In the Monte Carlo simulation, in order to get stable results, we used stratified sampling. The sample space is divided into 15×15 cells, and there are 100 samples in each cell.

The two independent variables in sampling are  $a/h$  and  $a/b$  in Fig. 1. Their probability density functions are shown in Eqs. 6, 7 and Figs. 6, 7.

$$p(a/h) = 2 \cdot \exp[-2 \cdot (a/h)] \quad (6)$$

$$p(a/b) = \frac{1.5 \cdot \exp[-1.5(\frac{1}{a/b} - 1)]}{(a/b)^2} \quad (7)$$

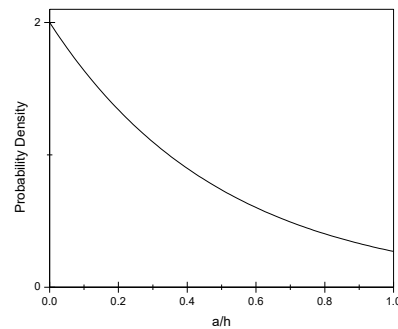

Fig.6 Probability density distribution of  $a/h$ .

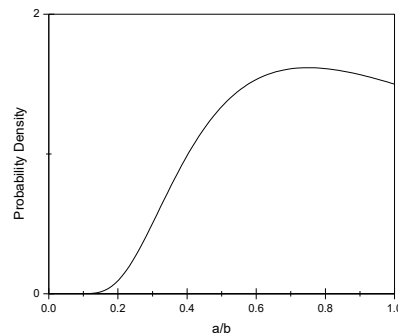

Fig.7 Probability density distribution of  $a/b$ .

### 4 Results and analysis

This study calculated and analyzed the influence of temperature, pressure, pipe wall thickness, outside diameter and ultrasonic inspection on break probability. For each condition, we selected several kinds of pipe sizes.

#### 4.1 Temperature

The parameters of two sizes of horizontal pressure pipes are shown in Table 1.

The variable is temperature difference between operation temperature and room temperature, it is maximum temperature excursion during each cyclic

loading. The operation pressure is 3.0MPa, and the temperature difference is 10~50°C.

**Table 1 Parameters of calculated pipes.**

	Outside Diameter	Wall Thickness	Pipe Length
Pipe1	22.0mm	3.0mm	2.4m
Pipe2	108.0mm	4.0mm	6.4m

Calculation result is shown in Fig. 8.

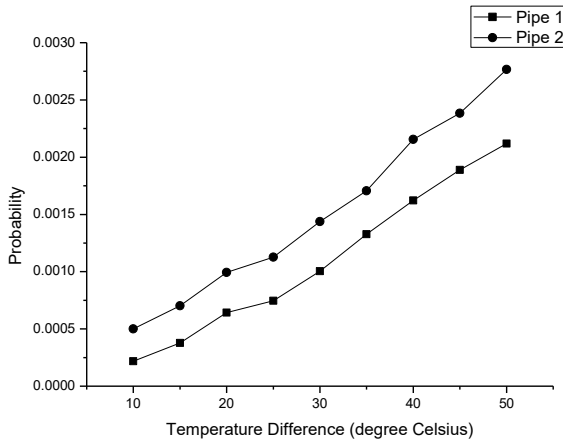

Fig.8 Break probability varies with temperature difference.

The probabilities in Fig. 8 is the break probabilities of pipes after 100 cyclic loadings. The result shows that, with the increase of temperature difference, the break probability increases. The reason for this phenomenon is that the increase of temperature difference results in the increase of thermal expansion stress, thus leading to the increase of effective cyclic stress intensity factors. So, the crack grows faster under a higher temperature difference (as shown in Fig. 9).

Figure 9 is the probabilities in every 10 cyclic loadings under 5 different temperature differences.

In Fig. 8, the break probability appears to increase linearly with the increase in temperature difference, but it is not a conclusion. Because break probability is influenced by many pipe parameters and operation conditions. In PRAISE algorithm, the linear relationship between break probability and temperature variation cannot be derived.

**4.2 Pressure**

The parameters of two sizes of pipes are shown in Table 2. The operation temperature difference is 50°C.

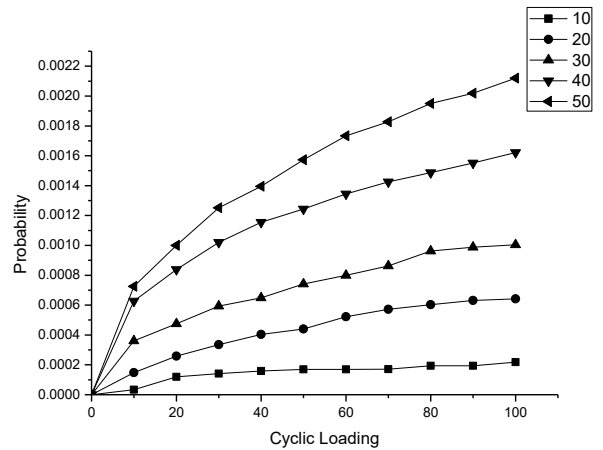

Fig.9 Probabilities in every 10 cyclic loadings under 5 different temperature differences.

**Table 2 Parameters of pipes about pressure.**

	Outside Diameter	Wall Thickness	Operation Pressure	Pipe Length
Pipe3	45.0mm	3.0mm	1.0~18.0MPa	3.8m
Pipe4	159.0mm	4.5mm	1.0~7.0MPa	8.0m

Calculation result is shown in Fig. 10.

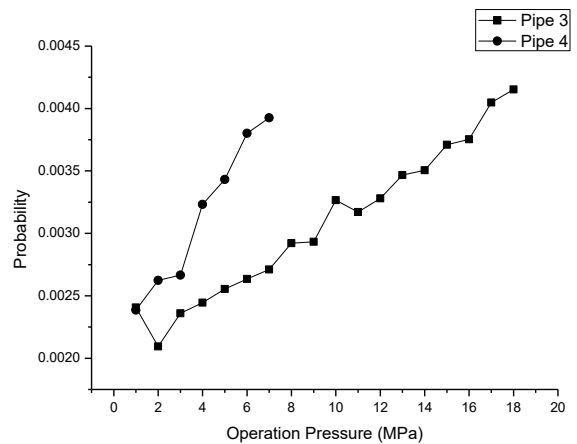

Fig.10 Break probability varies with pressure difference.

The result shows that, with the increase of operation pressure, the pipe break probability slightly increases. The reason for this phenomenon is that the increase of operation pressure leads to the increase of internal stress.

Compared with the influence of temperature, we find that temperature effects are greater than pressure because thermal expansion stress has a greater contribution to crack growth.

For pipe 3, there is a little oscillation under low pressure. The reason is that the operation pressure is far below the pressure limit of pipe 3, so the pressure is not the dominant factor of break probability.

Figure 11 is the probabilities in every 10 cyclic loadings under 5 different operation pressure. The plot shows that with higher pressure, the crack grows faster.

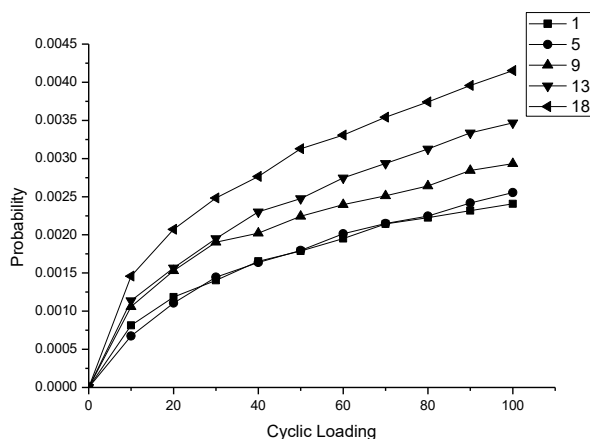

Fig.11 Probabilities in every 10 cyclic loadings.

### 4.3 Pipe wall thickness

The wall thicknesses of calculated pipes are shown in Table 3. The outside diameter and length of the pipes are 73.0mm and 5.2m. And the operation pressure and temperature difference is 8.0MPa and 50°C.

Table 3 Wall thicknesses of the pipes.

	Wall Thickness
Pipe5	4.0mm
Pipe6	4.5mm
Pipe7	5.0mm
Pipe8	5.5mm
Pipe9	6.0mm
Pipe10	6.5mm
Pipe11	7.0mm
Pipe12	7.5mm
Pipe13	8.0mm
Pipe14	8.5mm

Calculation result is shown in Fig. 12.

The result shows that, with the increase of pipe wall thickness, the pipe break probability decreases. The result meets the common sense.

In PRAISE algorithm, pipe break can be divided into different types according to the break area. Normally, the area of  $Dt/4$  is used to distinguish small LOCA and medium LOCA. Where  $D$  is the outside diameter and  $t$  is the pipe wall thickness. Figure 13 shows the probability of medium LOCA varying according to wall thickness.

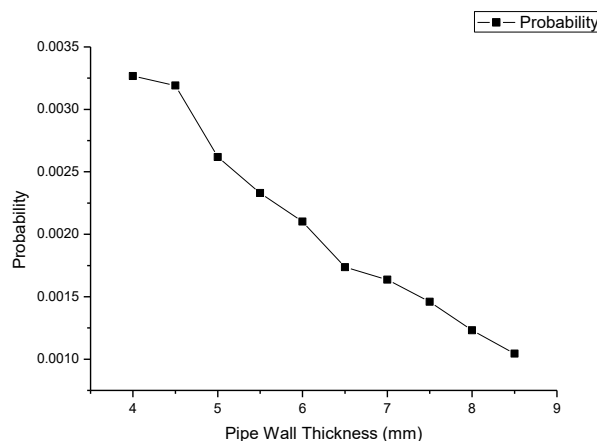

Fig.12 Break probability varies with wall thickness.

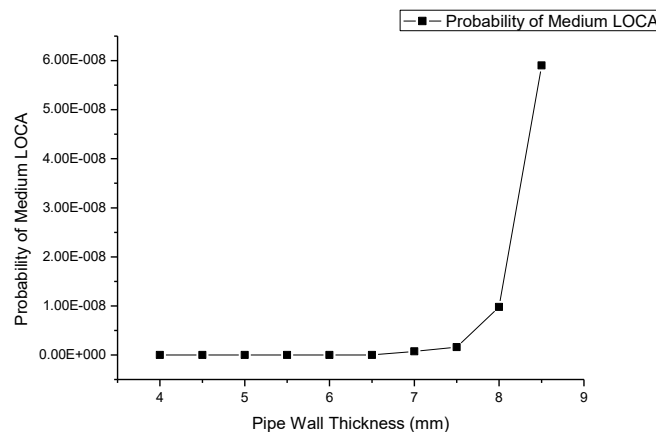

Fig.13 Probability of medium LOCA varies with wall thickness.

The plot shows that, with the increase of wall thickness, the probability of medium LOCA significantly increases. The reason for this phenomenon is, in PRAISE algorithm, the as-fabricated surface cracks are assumed to be semi-elliptical and remain semi-elliptical throughout the whole calculation process. Therefore, with a thick pipe wall, the shape of the break becomes distortion, so is the area. Therefore, the probability of medium LOCA increases. This phenomenon is caused by the assumptions of PRAISE algorithm, it is unreal.

### 4.4 Outside diameter

The outside diameters of calculated pipes are shown in Table 4. The wall thickness is 3.0mm. The operation pressure and temperature difference are 8.0MPa and 50°C, and the length of the pipes is 2.4m.

**Table 4 Outside diameters of the pipes.**

	Pipe15	Pipe16	Pipe17	Pipe18	Pipe19
Outside Diameter	22.0mm	28.0mm	32.0mm	38.0mm	45.0mm

Calculation result is shown in Fig. 14.

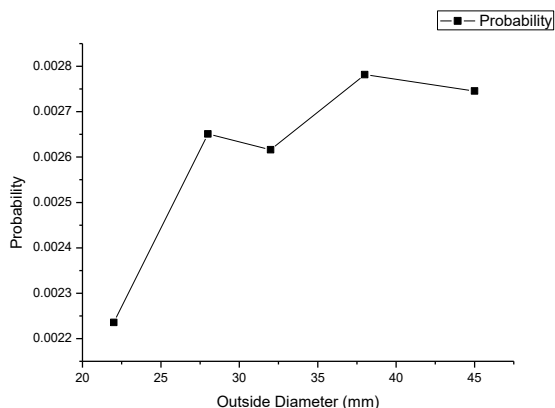

Fig.14 Break probability varies with outside diameter.

The result shows that there is no clear relationship between outside diameter and break probability.

### 4.5 Ultrasonic inspection

The parameters of calculated pipes about ultrasonic inspection are shown in Table 5.

**Table 5 Parameters of pipes about ultrasonic inspection. (Pipe 20)**

Outside Diameter	Wall Thickness	Operation Pressure	Temperature Difference	Pipe Length
159.0mm	4.5mm	2.0MPa	20°C	8.0m

The result shows that, by using pre-service and in-service inspections, the probability of pipe break significantly decreases from 2.09e-3 to 8.38e-4. It turns out that ultrasonic inspection is helpful for reducing the probability of pipe break.

Calculation result is shown in Fig. 15.

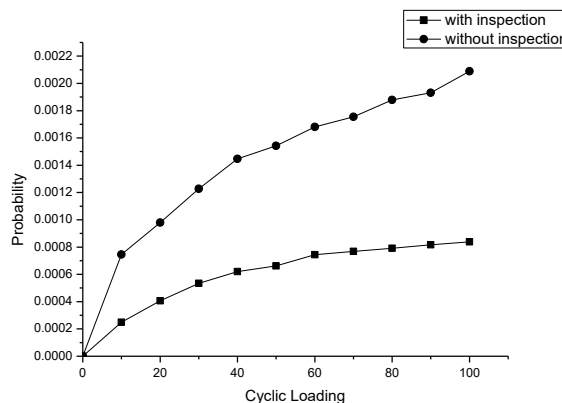

Fig.15 Probabilities in every 10 cyclic loadings.

## 5 Conclusion

This study referred to the algorithm of PRAISE computer code. Calculated several horizontal pressure pipes of different sizes under different operation conditions. The conclusions are as follows:

- 1) The rise of operation temperature and pressure increases the break probability, and operation temperature has more contribution than pressure to pipe break.
- 2) The rise of the wall thickness decreases the break probability.
- 3) There is no clear relationship between outside diameter and break probability.
- 4) By using ultrasonic examination as pre-service and in-service inspections, the probability of pipe break can be effectively reduced.

## Acknowledgement

This work was supported by Nuclear Power Institute of China [grant number CETR-E1201-QT-HT-028].

## References

- [1] LIM, E.Y.: *PRAISE Computer Code User's Manual*. Vol. 9. NUREG/CR-2189.
- [2] 2008, GB/T17395. *Dimensions, Shapes, Masses and Tolerances of Seamless Steel Tubes [S]*. Diss.
- [3] 2000, GB50316. *Design Code for Industrial Metallic Piping [S]*. Diss. 2008.
- [4] SHI, Z.Q., ZHAO, T.Y.: *Power piping design manual. [M]*. Beijing: China Machine Press. 2006.(In Chinese)