

Visualization experimental research on the movement characteristics of bubbles escaping from twin-orifice wall

HUANG Ying¹, GAO Puzhen², WANG Chaoqun¹, and WANG Zhongyi¹

1. Fundamental Science on Nuclear Safety and Simulation Technology Laboratory, Harbin Engineering University, Harbin, Heilongjiang, 150001, China (huangxiaopang@hrbeu.edu.cn)

2. Fundamental Science on Nuclear Safety and Simulation Technology Laboratory, Harbin Engineering University, Harbin, Heilongjiang, 150001, China (gaopuzhen@sina.com)

Abstract: The movement characteristics of bubbles escaping from twin-orifices wall were studied through visualization experiment. The rising trajectories, detachment size and velocity of two columns of bubbles were analyzed under the conditions of different orifice sizes and orifice spacing. Besides, they were compared with single - orifice bubbles generation and movement characteristics, and the law of influence of the orifice sizes and orifice spacing was obtained. According to the experimental results, when two columns of bubbles rose side by side, they oscillated horizontally, showing a cycle process of getting close to each other -- getting away from each other -- and then getting close to each other. And the smaller the orifice spacing was, the larger amplitude the horizontal oscillation accompanied by the rising of the bubbles was. Under the same orifice size and gas flow rate, the smaller the orifice spacing was, the smaller bubble size at detachment, the lower the final stable velocity of the bubble. By contrast, under the same orifice spacing and gas flow rate, the larger the orifice size was, the larger bubble size at detachment was, the greater difference between the detachment size and single-orifice condition, and the higher final stable velocity of the bubble.

Keyword: bubble; two phase flow; visualization experiment; trajectory

1 Introduction

Gas-liquid two-phase flow widely exists in nature and various industrial processes, such as chemical industry, petroleum, new energy and national defense [1-8]. Two-phase flow phenomenon often occurs in the field of nuclear energy engineering, and gas-liquid two-phase flow directly affects the heat and mass transfer performance of equipment and even the safety of equipment. The form of the gas phase in water and the motion law are the key factors influencing the two-phase flow characteristics. In the actual production process, there are large numbers of bubbles in the equipment that have various shapes, sizes and velocity, and they influence each other, so their movement characteristics are different from the single bubble. Therefore, the research on the movement characteristics of bubbles and the interaction between bubbles has important value and significance for nuclear power involving two-phase flow and many engineering fields [9-15].

Muller *et al.* conducted the visualization experiment

research about the formation characteristics of underwater single-porosity bubbles. They found that the bubble size was mainly determined by orifice diameter, surface tension and the density difference between two fluids in the case of very small gas flow rate, and that the bubble size increased with the increase of gas flow rate in the case of relatively large gas flow rate [16]. C. Aladjem Talvy studied the interaction between two continuous bubbles in the vertical tube through experiment, and believed that the motion characteristics of the two bubbles were mainly determined by the forward bubble, and the trailing bubble was quite sensitive to the velocity changes of the forward bubble wake [17]. Roland Rzehak theoretically analyzed the forces acting between two bubbles in different positions, and proposed a new bubble coalescence and crushing model [18]. Thodoris Karapantsios conducted experimental research on the collision process of two bubbles with quite different volumes, and established a theoretical model for the velocity and trajectory of small bubbles when getting close to large bubbles [19]. Cao and Christensen simulated the bubble collapse in a binary solution by means of the transformed Navier–Stokes equation into the stream function and velocity in axisymmetric moving non-orthogonal

Received date: August 20, 2018

(Revised date: January 10, 2019)

body-fitted coordinates [20]. Del Valle and Kenning investigated the bubble size, life span and frequency as well as the interaction of nucleation sites in high heat flux [21]. Bibeau *et al.* made a study on the motion of single bubble rising in upward shear liquid flow in the vicinity of a vertical wall [22]. Lin and Lin has proposed that for two in-line bubbles, the acceleration of the trailing bubble to the leading bubble owes to the dragging force caused by the negative pressure in addition to the pushing force caused by the viscoelastic effect [23]. Fan *et al.* focused the rise and interaction between two parallel rising bubbles by analyzing the velocity field around bubbles using particle image velocimetry (PIV) [24].

Previous studies on the formation characteristics of bubbles mainly focus on the movement law of single bubbles, and some studies on bubble collision and coalescence mainly focus on the vertical co-axial distribution, while there are few studies on the rising

process of horizontally-distributed bubble pairs and the interaction between two bubbles. In this paper, the bubbling behavior of the twin-orifice wall was studied through visualization experiment, and the movement characteristics of the formation process of the two-column bubbles were analyzed. By comparison with the formation and movement characteristics of single-orifice bubbles, the effect of orifice spacing and orifice size on the interaction between bubbles was analyzed.

2 Experimental system and measurements

2.1 Experimental device and system

Figure 1 is a schematic diagram of the experimental system. The experimental device is composed of water tank, bracket, float flow meter, LED plane light source, bubble generation module, check valve, air pump, high-speed camera and computer.

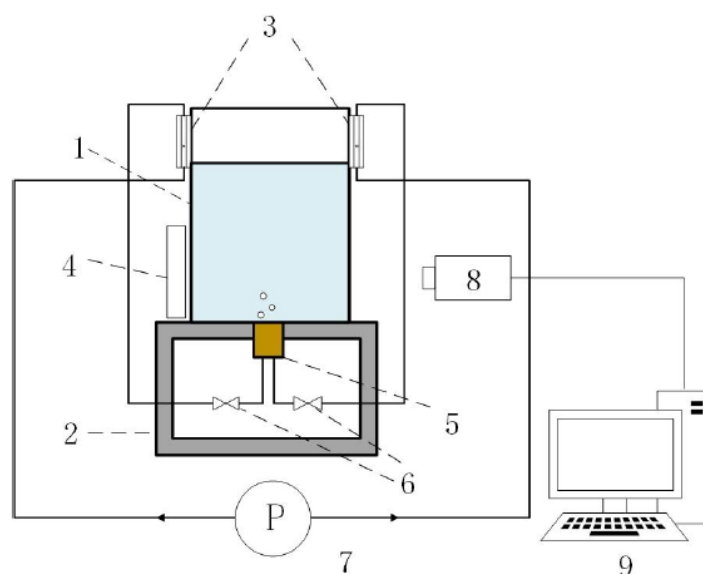

Fig.1 Experimental device and system.

1-water tank 2-bracket 3-float flow meter 4-LED plane light source 5-bubble generation module 6-check valve 7-air pump
8- high-speed camera 9- computer.

Visual water tank was a transparent container, which was made of organic glass. Its size was 300mm×300mm×300mm, and the shoot direction size was 300mm×500mm. Moreover, it contained pure water with the height of 300mm; inside orifice at the bottom of the tank were used to install bubble generation component, the bubble generation component was shown in Fig.2, on which two

orifices was drilled, they had the same diameter of orifice. Under the three conditions ($d_o = 1.5\text{mm}$, $d_o = 2\text{mm}$ and $d_o = 2.5\text{mm}$, respectively, where d_o is diameter of orifice), the double circle orifice spacing was $d = 3\text{mm}$, $d = 8\text{mm}$ and $d = 12\text{mm}$, respectively, where d is distance between two orifice.

The gas was provided by HP-1116 electromagnetic

vibrating air flow pump with the rated voltage of 220V/50Hz, and the rated power of 15W. Its maximum gas displacement could reach 10L/min. In the experiment, LZB-3 tiny flow glass rotor flow meter with a range of 16-160mL/min was selected to control the gas flow into the gas orifice by adjusting the float flow meter.

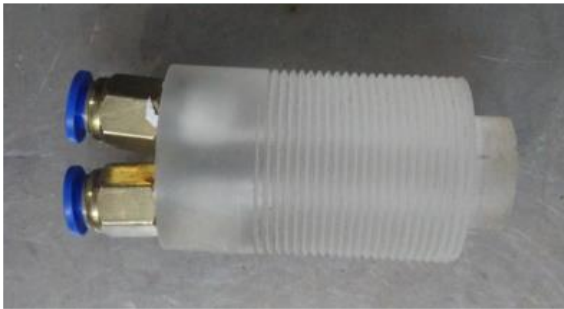

Fig.2 Bubble generation module.

The formation process of bubbles was captured by a high-speed camera instrument, and the camera parameters were adjusted through PFV (Photron FASTCAM Viewer) software equipped with the camera. To capture clearer images, the high-speed camera instrument was supplemented with the LED plane light source of 300mm×300mm and rated power of 12W in the experiment.

2.2 Image processing and parameter measurement

2.2.1 Image processing method

In the paper, IPP (Image-Pro Plus) software was used to process the video shots frame by frame. Bubbles were approximately spherical when they escaped, while they showed irregular shape in the following movement process. Image edge area could be automatically identified and separated through IPP software. AOI (Area Of Interesting) was selected for measurement. In the case of few very serious background disturbance, AOI could be also manually selected for measurement, with the measurement contents including coordinates, distance and area. As shown in Fig.3, the ruler and the fitting boundary of bubbles were obtained by using IPP.

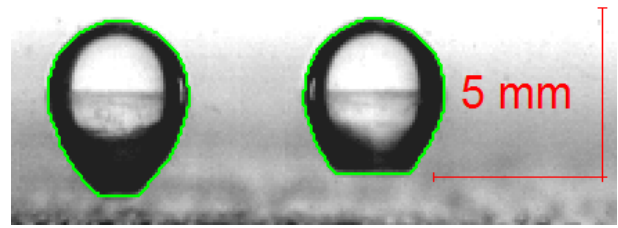

Fig.3 AOI selected of bubble.

2.2.2 Calculation of bubble parameters

The size, velocity and position of bubbles are the key feature parameters in the transport process. During the experiment, the shooting speed of the high-speed camera was certain, and the time difference of each frame image was known. Therefore, the characteristic parameters of the bubble could be obtained by comparing the position and size differences of bubbles in the two frames of images, and then the rising trajectories, detachment size and velocity change regulation could be tracked.

Profiles of a bubble in three adjacent images is shown in Fig.4. Its velocity could be calculated in term of its centroid positions at two adjacent frames and the time interval:

$$v_{x,i+1} = \frac{x_{i+1} - x_i}{\delta t}$$

$$v_{y,i+1} = \frac{y_{i+1} - y_i}{\delta t}$$

Where $v_{x,i+1}$ and $v_{y,i+1}$ are the velocity component in x and y directions respectively, and δt is the time interval with a fixed value of 1 ms in the current experiments.

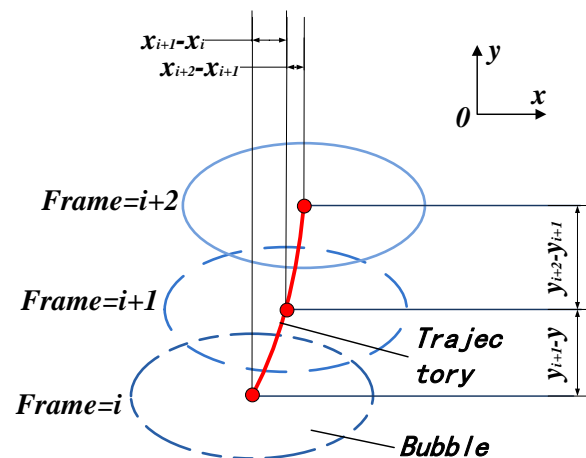

Fig.4 Bubble parameter calculation method.

2.2.3 Error analysis

The measurement accuracies of bubble parameters are crucial for the reliability of the subsequent analysis. The flow rate of gas are directly measured, the errors of it are usually determined by the characteristics of measurement instruments themselves. The relative error of flow measurement is 2.5% without considering the factitiousness operate and reading error.

Besides the errors arising from the measurement in experiments, image resolution also induces uncertainties during detecting the bubble edge by digital image analysis in the measurements of bubble size and motion parameters.

In the experiment, the filming frame rate and resolution are set to 5000 fps and 1240×1240 pixels. The corresponding physical scale of the view window is about $100 \times 180 \text{ mm}^2$, since the uncertainty for locating the position is within ± 0.5 pixels, the maximum error of bubble location in x direction is limited to $\pm 0.049 \text{ mm}$ and the maximum error of bubble location in y direction is limited to $\pm 0.09 \text{ mm}$. The maximum error of bubble diameter is limited to $\pm 0.09 \times 2 = \pm 0.18 \text{ mm}$. In the experiment, the diameter of the bubbles is more than 4.3 mm . The maximum relative error of bubble diameter is: $0.18 \div 4.3 \times 100\% = 4.18\%$.

3 Experimental results and discussion

3.1 Effect of orifice spacing on bubble characteristics

When diameter of orifice was 2 mm , the bubble characteristics of different flow rates under four conditions (orifice spacing of $d = 3 \text{ mm}$, 8 mm and 12 mm , and single orifice) were studied through experiment. Moreover, the bubble size at detachment under the four conditions were extracted, with the results shown in Fig.5. As it shows, when the gas flow was within $40 \sim 120 \text{ mL/min}$, the bubble size at detachment increased with the increase of the inlet gas-flow rate. Plus, the bubble size at detachment of twin-orifices condition was the average size of the two bubbles.

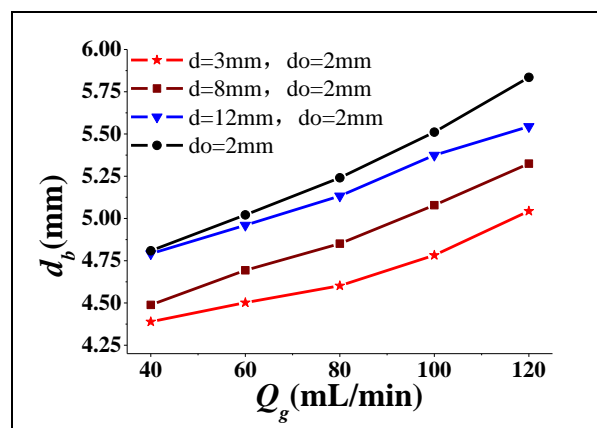

Fig.5 Bubble departure diameter.

For double orifices condition, orifice spacing had a significant impact on the bubble size at detachment. To be specific, for the smaller orifice spacing, the bubbles mutually influenced each other in the growth process, and inhibited the growth of each other. Therefore, in the case of the same orifice size and gas flow rate, bubbles of double orifices condition had smaller detachment size than single orifice condition; the smaller the orifice spacing was, the greater their value difference would be. In the case of the same orifice size and orifice spacing, the larger the gas flow rate was, the larger the bubble detachment size would be. As a result, the relative distance between bubbles in the growth process became smaller, and they had stronger inhibiting effect on each other, and greater differences with single orifice in terms of detachment size.

Figure 6 shows the change regulation of bubble velocity over time and the fitting curve of bubble velocity variation over time in the condition of a single orifice with a diameter of orifice of 2 mm . As seen from the overall trends, after the bubble detachment, there was a deceleration process; bubble rising velocity would increase rapidly after reducing to the minimum velocity, and then velocity increased slowly; finally, the bubbles rose at approximate uniform velocity. And the deformation characteristics were accompanied by the rising process of the bubbles, resulting in partial energy conversion between deformation energy and kinetic energy. Therefore, the bubble velocity would reflect a rising trend, which was accompanied by slight velocity fluctuation.

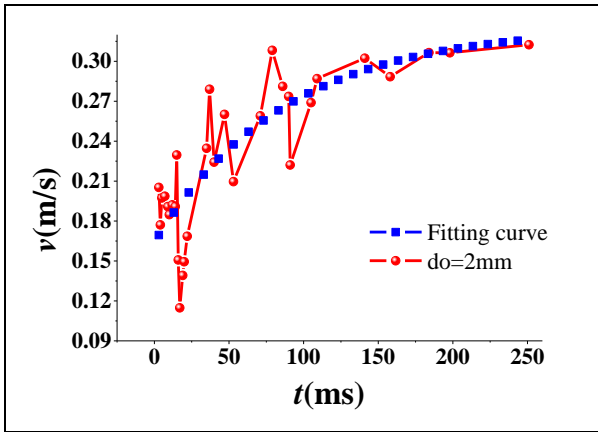

Fig. 6 Bubble velocity variation over time.

Figure 7 shows the change regulation of bubble velocity over time under different orifice spacing condition. It can be found that bubble velocity variation showed almost the same change trend; The final stable velocity of bubbles under different orifice spacing was slightly different, and they still showed a certain regularity: when the gas flow rate and orifice size remained the same, the smaller the orifice spacing was, the smaller the final stable velocity bubbles had. Stokes *et al.* deduced the theoretical formula of the final rising velocity of single spherical smaller bubble [25].

$$v_{final} = \frac{1}{18} \frac{\rho_l - \rho_g}{\mu_l} g d_b^2$$

Where, v_{final} is the final stable velocity of the bubble. ρ_l and ρ_g are the density of water and air, respectively. μ_l is the viscosity of water, and d_b is the diameter of the bubble. It can be seen that the final velocity of the bubble was related to the size of the bubble. To be specific, the smaller the orifice spacing was, the smaller the bubble size would be, which would slow down the final velocity of the bubble.

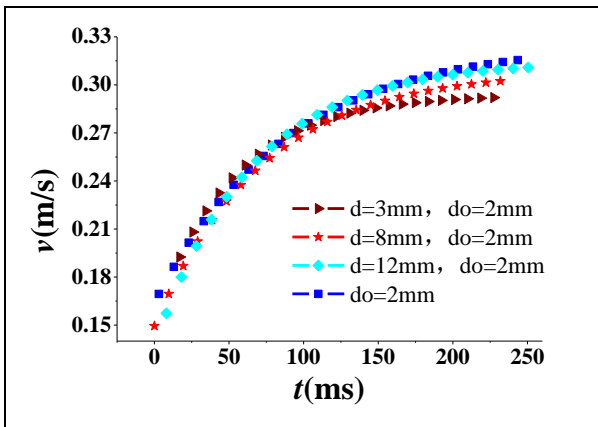

Fig.7 Velocity variation with time under different conditions.

3.2 Effect of diameter of orifice size on bubble characteristics

When orifice spacing was 8mm, the bubble characteristics of different flow rates under three conditions (diameter of orifice: $d = 3\text{mm}$, 8mm and 12mm) were studied through experiment. Moreover, the bubble size at detachment under the three conditions were extracted. The results were compared with the experimental results under the conditions of single orifice with the same diameter of orifice. The detachment size of bubbles increased with the increase of the inlet gas-flow rate and diameter of orifice size. It can be seen from the Fig.8 that in the case of the same orifice spacing and gas flow rate, bubbles of double orifices condition had smaller detachment size than single orifice condition; the greater the diameter of orifice was, the greater their difference value would be. That is because the larger the orifice size, the larger the bubble generated, and even if the orifice spacing remains unchanged, the bubble centroid distance does not change, but the minimum distance between the two bubbles becomes smaller, and the influence of the two bubbles is enhanced, resulting in a larger difference value.

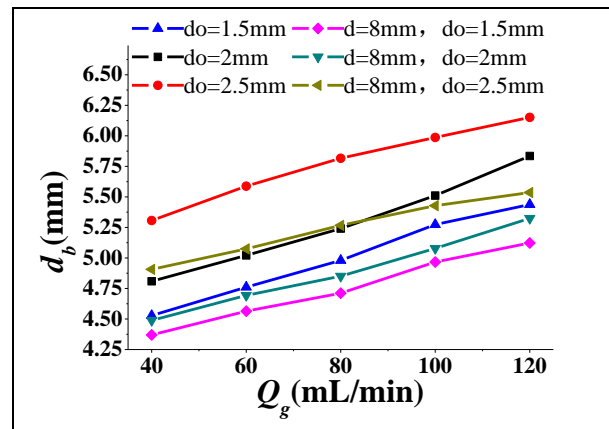

Fig.8 Bubble departure diameter.

Figure 9 shows the change law of bubble rising velocity with time under different hole sizes. It was found that the change trend of bubble velocity was the same as that described above. And when the gas flow rate and orifice spacing remained the same, the smaller the orifice size was, the smaller final stable velocity bubbles had. According to the Stokes' theory, it can be seen that the final velocity of the bubble was related to the size of the

bubble, the smaller the orifice size was, the smaller the bubble size would be, which would slow down the final velocity of the bubble.

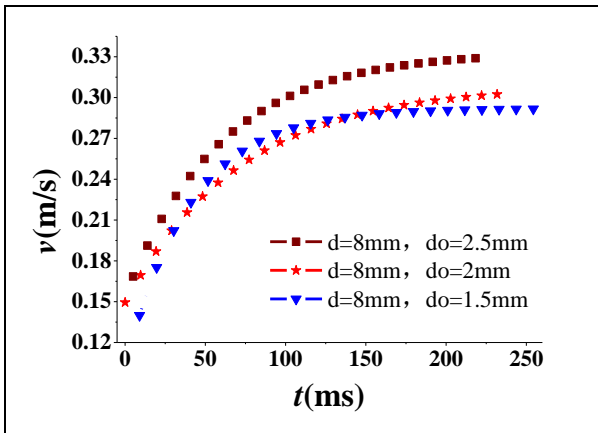

Fig.9 Velocity variation with time under different conditions.

3.3 The rising trajectory of bubbles under different orifice spacing

Under the orifice size of 2mm, and gas flow rate of 40 mL/min, the four conditions (orifice spacing of $d = 3\text{mm}$, 8mm and 12mm respectively, and single hole) were shot; rising process of the bubbles were traced, and then their rising trajectories were obtained. As shown in Fig.10, bubbles mutually influenced when two columns of bubbles rose side by side; rather than linear rising trajectory, bubbles oscillated horizontally while

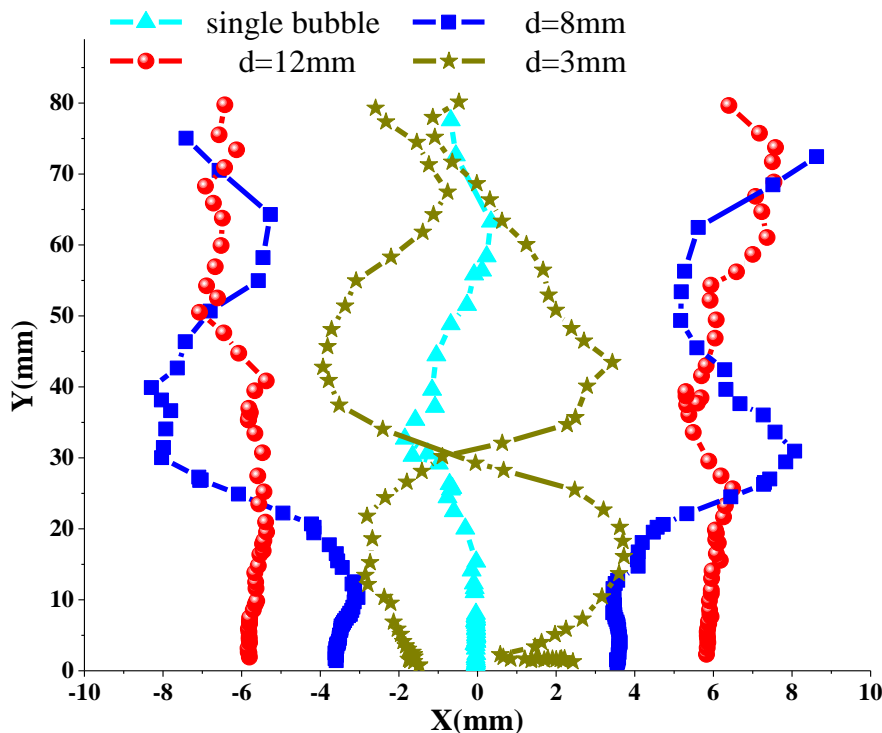

Fig.10 Bubble rising trajectory.

rising, had the cycle process of getting close to each other - getting away from each other - and then getting close to each other. Fig.12 were the images taken by the experimental conditions of the diameter of orifice $d_o = 2\text{mm}$, the gas flow rate of 40 ml/min , and the orifice spacing $d = 8\text{mm}$, showed the variation of the relative position of two bubbles during the rising process. It could be found that the two bubbles were close to each other firstly, when the distance was very small, the two bubbles would gradually separate, and the distance would gradually become larger, when the two bubbles were far apart, the two bubbles would gradually approach again.

In addition, when the orifice spacing was small, rising crossover phenomenon would occur in the process. Based on Fig.5, instead of perfectly straight rising trajectory, single column of bubbles also slightly oscillated horizontally. Compared with the condition of single bubble, when two columns of bubbles rose, the smaller the orifice spacing was, the greater oscillation amplitude bubbles had; the larger the orifice spacing was, the smaller oscillation amplitude bubbles had, and the closer the bubble rising trajectory to the single bubble rising trajectory.

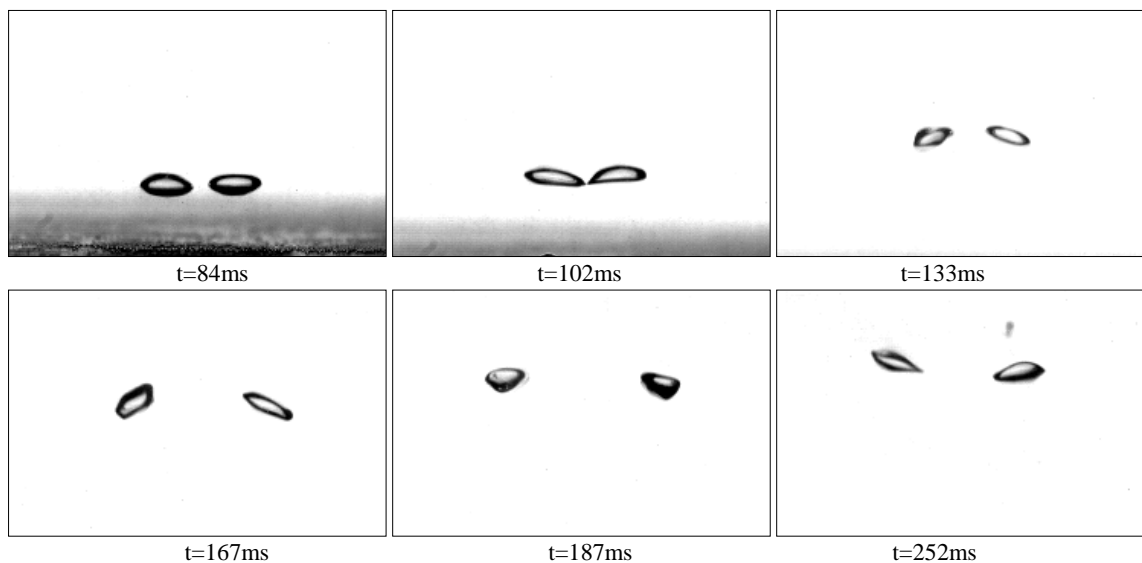

Fig.11 Relative position of bubbles changing with time.

4 Conclusion

In this paper, the bubble characteristics of different flow rates under different conditions of different orifice sizes and orifice spacing were studied through visualization experiment. By analyzing the effect of orifice size and orifice spacing on bubble rising trajectories, detachment size and velocity, the following conclusions can be drawn:

(1) bubbles of double orifices condition had smaller detachment size than single orifice condition, in the case of the same orifice size and gas flow rate, the smaller the orifice spacing was, the smaller bubble size at detachment was; the greater their difference value would be and the smaller final stable velocity bubbles had.

(2) In the case of the same orifice size and orifice spacing, the larger the gas flow rate was, the larger the bubble detachment size would be, the greater value difference between the detachment size and single-orifice condition.

(3) In the case of the same orifice spacing and gas flow rate, the greater the orifice size was, the larger the bubble detachment size would be, the greater value difference between the detachment size and single-orifice condition, and the greater final stable velocity bubbles had.

(4) When two columns of bubbles rose side by side, they oscillate horizontally, rather than rise in the linear form, and showing a cycle process of getting close to each other -- getting away from each other -- and then getting close to each other. And the smaller the orifice spacing was, the larger amplitude the horizontal oscillation accompanied by the rising of the bubbles was.

Nomenclature

t	time
d	distance between two orifice
d_o	diameter of orifice
d_b	diameter of bubble
g	acceleration of gravity
Q	flow rate
v	velocity

Greek letters

ρ	density
μ	viscosity

Subscripts

b	bubble
g	gas
l	liquid (water)

Acknowledgement

The authors greatly appreciate the support of Fundamental Science on Nuclear Safety and Simulation Technology Laboratory, Harbin Engineering University, College of Nuclear Science and Technology, China. The authors wish to thank the

LLOYD'S REGISTER FOUNDATION for financial support. The LLOYD'S REGISTER FOUNDATION is an independent charity working to achieve advances in transportation, science, engineering and technology education, training and research worldwide for the benefit of all.

References

- [1] PAINMANAKUL, P., LOUBIERE, K., and HEBRARD, G., *et al.*: Study of different membrane spargers used in waste water treatment: characterisation and performance[J]. *Chem Eng Process*, 2004, 43(11): 1347-1359.
- [2] LAU, R., MO, R., and W.S. BEVERLY, SIM.: Bubble characteristics in shallow bubble column reactors[J]. *Chem Eng Res Des*, 2010, 88(2):197-203.
- [3] C.P. RIBEIRO, JR., and P.L.C. LAGE: Experimental study on bubble size distributions in adirect-contact evaporator[J]. *Braz J Chem Eng*, 2004, 21(1):69-81.
- [4] XIE, Y.B., LIU, D.P., and YANG, L., *et al.*: Experimental study on the growth characteristics of natural gas hydrate formation on suspended gas bubbles in distilled water and tap water[J]. *Chemical Industry and Engineering Progress*, 2017, 36(1)129-135[in Chinese].
- [5] ZHOU, Q., GUO, X.F., and LI, J., *et al.*: Comparative investigation on closure models for the simulation of vertical gas-liquid bubbly upflow[J]. *Chemical Industry and Engineering Progress*, 2016, 35(10)3049-3056[in Chinese].
- [6] YAN, H., ZHU, C.Y., and MA, Y.G., *et al.*: Continuous formation and coalescence of bubbles through double-nozzle in non-Newtonian fluid[J]. *Chemical Engineering(CHINA)*, 2016, 44(8):37-41[in Chinese].
- [7] DING, Y.D., LIAO, Q., and ZHU, X., *et al.*: Characteristics of bubble growth and water invasion at the permeable sidewall in rectangular liquid flow channel[J]. *Journal Of Mechanical Engineering*, 2013, 49(14):119-124[in Chinese].
- [8] DU, Y.H., XIONG, K.W., and ZHANG, Y., *et al.*: Analysis of numerical simulation on horizontal arrangement equal bubbles rising[J]. *Chinese journal of computational mechanics*, 2016, 33(6):889-894[in Chinese].
- [9] SAGERT, N.H., and QUINN, M.J.: Influence of high-pressure gases on the stability of thin aqueous films[J]. *Journal of Colloid and Interface Science*, 1977, 61:279–286.
- [10] SAGERT, N.H., and QUINN, M.J.: Surface viscosities at high pressure gas–liquid interfaces[J]. *Journal of Colloid and Interface Science*, 1978, 65:415–422.
- [11] YOO, D.H., TSUGE, H., and TERASAKA, K., *et al.*: Behavior of bubble formation in suspended solution for an elevated pressure system[J]. *Chemical Engineering Science*, 1997, 52:3701–3707.
- [12] GNYLOSKURENKO, S., BYAKOVA, A., and RAYCHENKO, O., *et al.*: Influence of wetting conditions on bubble formation at orifice in an inviscidliquid. Transformation of bubble shape and size. *Colloids and Surface[J]. A: Physicochemical and Engineering Aspects*, 2003, 218:73–87.
- [13] GNYLOSKURENKO, S., BYAKOVA, A., and NAKAMURA, T., *et al.*: Influence of wettability on bubble formation in liquid[J]. *Journal of Material Science*, 2005, 40:2437–2441.
- [14] GADDIS, E.S., and VOGELPOHL, A.: Bubble formation in quiescent liquids under constant flow conditions[J]. *Chemical Engineering Science*, 1986, 41(1):97-105.
- [15] CHEN, Y., GROLL, M., and MERTZ, R., *et al.*: Force analysisi for isolated bubbles growing from smooth and evaporator tubes[J], 2003.
- [16] MULLER, R.L., and PRINCE, R.G.H.: Regimes of bubbling and jetting from submerged orifices[J]. *Chemical Engineering Journal*, 1972, 27(8):1583.
- [17] TALVY, C. A., SHEMER, L., and BARNEA, D.: On the interaction between two consecutive elongated bubbles in a vertical pipe[J]. *International Journal of Multiphase Flow*, 2000(26):1905-1923:
- [18] LIAO, Y.X., ROLAND, R., and DIRK, L.: Baseline closure model for dispersed bubbly flow: Bubble coalescence and breakup[J]. *Chemical Engineering Science*, 2015(122):336–349.
- [19] ZUZANA, B., THODORIS, K., and MARGARITIS, K.: Bubble–particle collision interaction in flotation systems[J]. *Colloids and Surfaces A: Physicochemical and Engineering Aspects*, 2015, 473:95–103.
- [20] CAO, J., and R.N. CHRISTENSEN: Analysis of moving boundary problem for bubble collapse in binary solutions[J]. *Numerical Heat Transfer Part A*, 2000, 38:681–699.
- [21] DEL, V., and V.H. KENNING, *et al.*: Subcooled Flow Boiling at high heat flux[J]. *Heat Mass Transfer*, 1985, 28:1907-1920.
- [22] ALEXANDER, Z., DIRK, L., and HORST-MICHAEL P., *et al.*: Bubble-wall interaction in a vertical gas-liquid flow: Bouncing, sliding and bubble deformations[J]. *Chemical Engineering Science*, 2007, 62:1591-1605.
- [23] LIN, T.J., and LIN, G.M.: Mechanisms of in-line coalescence of two-unequal bubbles in a non-Newtonian fluid[J]. *Chem. Eng J*, 2009, 155:750-756.
- [24] FAN, W.Y., MA, Y.G., and LI, X.L., *et al.*: Study on the flow field around two parallel moving bubbles and interaction between bubbles rising in CMC solutions by PIV[J]. *Chin. J. Chem. Eng*, 2009, 17:904-913.
- [25] WILLIAM, T.: *Mathematical and physical papers[M]*. London: Cambrige University Press, 1880.